

Intelligent Point-of-Care Terminal

NEW

POCi-W22C-RPL
POCi-W24C-RPL

22" / 24" Medical Panel PC with 13th Generation Intel® mobile Core™ i7/i5 processor

Features

- Dual reading light
- Chemical etching AG coating
- Modular PCIe x4 expansion slot
- Aluminum front bezel (IP66) & PC/ABS rear cover
- FHD IPS panel with optional DICOM preset module
- 13th Generation Intel® Raptor Lake-P platform
- Built-in medical-grade power supply



• Intelligent Working Station

The POCi series is a medical panel PC featuring AI, edge computing with rich expansion functions. It is ideal to work in many kinds of medical scenario such as radiology, telemedicine, endoscopy system or surgical working station.

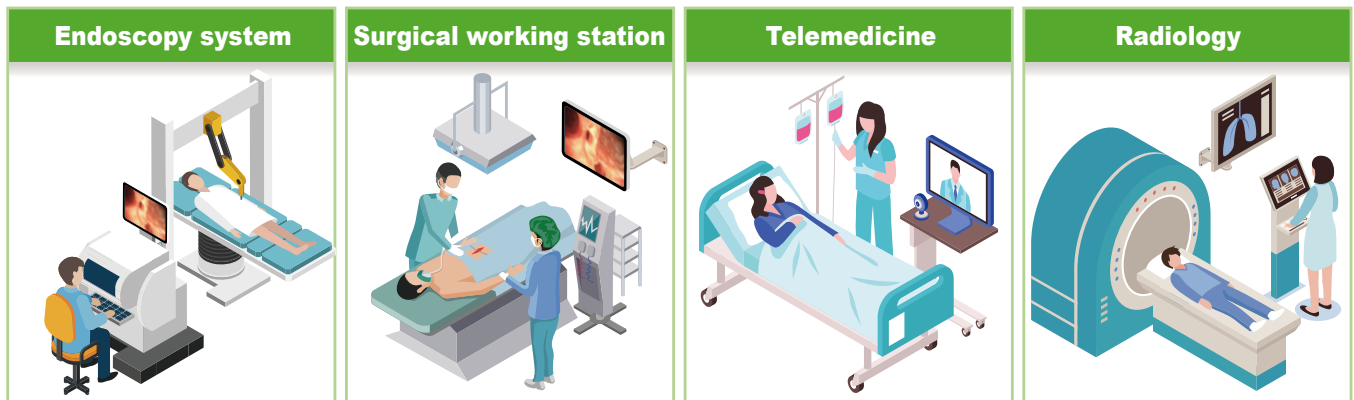

• IPS Panel with Chemical Etching AG Coating Glass

High-performance IPS panel enables a wider 178° viewing angles and advanced visual performance. The chemical etching AG coating reduces the watching fatigue resulting from glare or any other light interference in different kinds of environments.

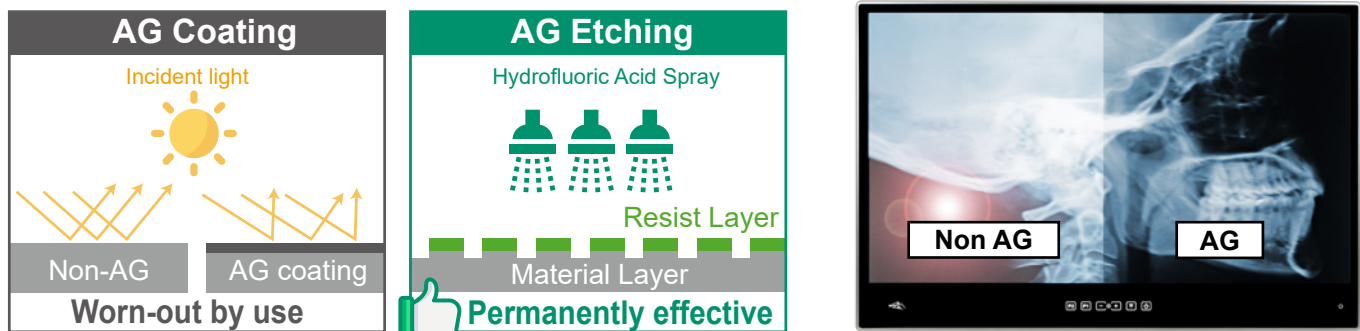

» Intelligent Point of Care Terminal

● Ultra-slim Aluminum Front Bezel

The ultra-slim front bezel creates a premium user experience. This design lets the medical personnel more focus on the clinical information displayed on the screen.



● Optional DICOM Preset

The way the human eye responds to contrasts in light levels is not linear. At low levels, we can notice small changes in luminance. At higher luminance, the change needs to be much greater before we perceive the difference from one level to the next. Calibration of the display system is important to ensure that each image is shown consistently every time it is viewed.

* To order the POCi series with DICOM module, please contact IEI's product manager for more information.



● Dual Reading Lights

The IEC 62471 compliant LEDs assure the reading light emits comfortable and safe light for human eyes. Easy adjustable dimming interface allows the user to choose the best brightness in different situations.



● ESD Protection

IEI provides Electrostatic discharge (ESD) 15kV (air) and 8kV (contact) ESD Protection. It can protect the circuit of a device from an Electrostatic discharge (ESD), in order to prevent malfunction of device.

● Chemical Resistance for Easy Sterilization

Sterilization is a daily routine of hospitals. Aluminum front frame is not only lightweight but also very durable for chemical erosion. The PC/ABS back cover is also carefully selected and proved to be resistant to the commonly seen detergents.



● IP Protection

IP66 front bezel and cover are easy to be cleaned with cleaners.

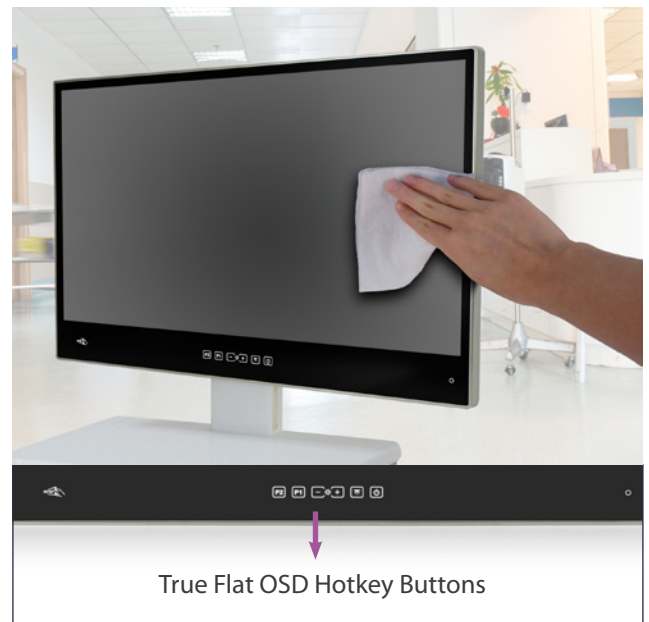

● True Flat OSD Hotkey Buttons

True flat OSD button design with no inaccessible corner brings conveniences for the cleaning personnel and increases cleaning efficiency.

● Wi-Fi 6E Module

The POCi-W22/24C-RPL supports the latest Wi-Fi 6E standard which enables more clients in dense environments and will provide a better experience for typical wireless LAN networks.

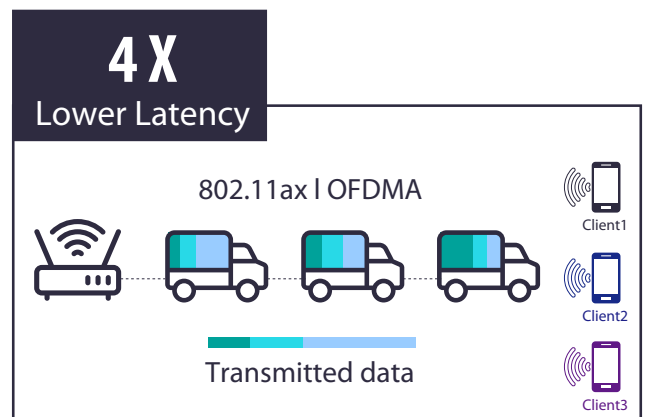
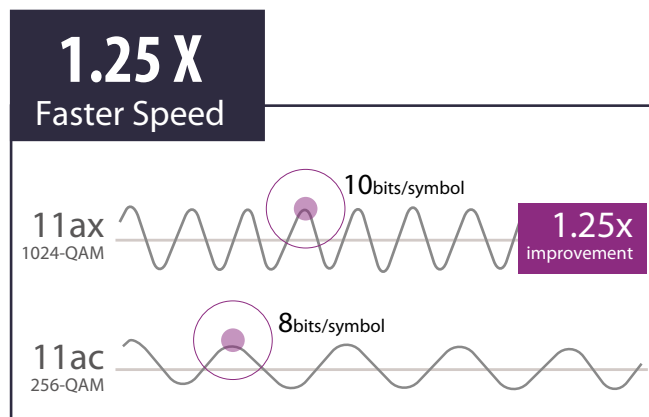
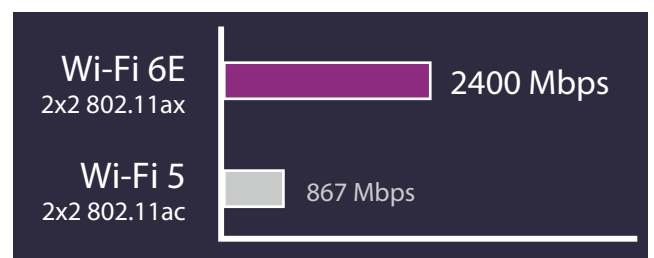

● Storage Device

The POCi-W22C-RPL provides flexible options for storage
 * M.2 M key slot for NVMe, up to PCIe 3.0 x4

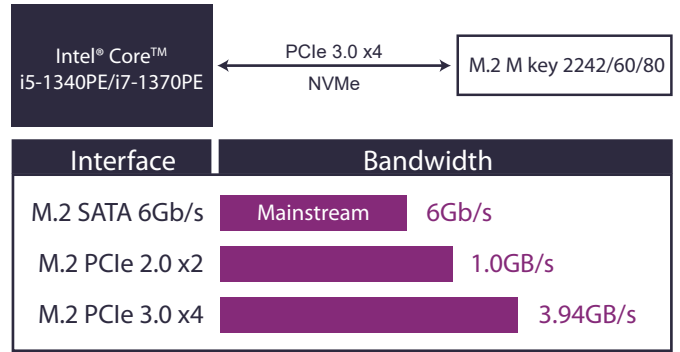

● Accessible HDD Cover & Cable Cover

Users can easily manage all the cables from the I/O ports, preventing splash to IO ports or messy cabling. Accessible HDD cover makes the IT maintenance job more efficient.

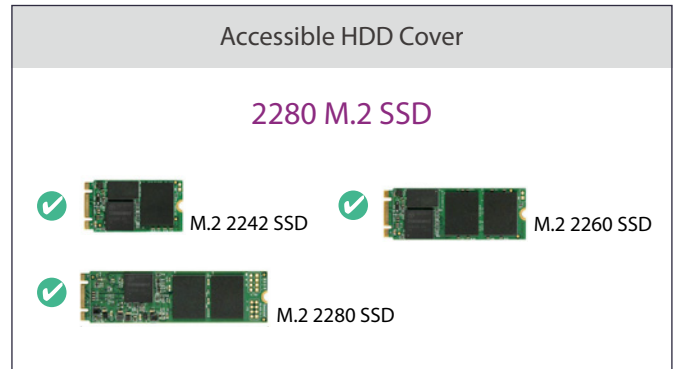
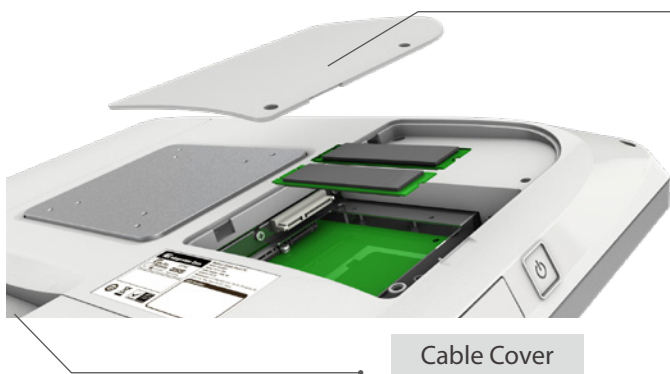

● Modular Expansion Design

The highly expandable PCIe x4 slot makes the whole system more flexible and easily meet the individual needs from different applications. For instance, adopting the AI accelerator card to enhance computing power, adding an all-in-one capture card to connect with medical devices, integrating PoE injector card with webcam, or expanding the desired I/O card for multiple usage.

PoE Injector Card

Isolation I/O Card

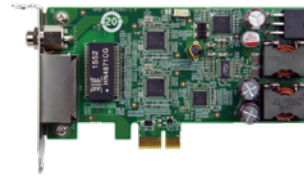

● Built-in Power

To implement the built-in medical-grade power supply system, simply connect the power cord to the system without the use of an external power adapter.

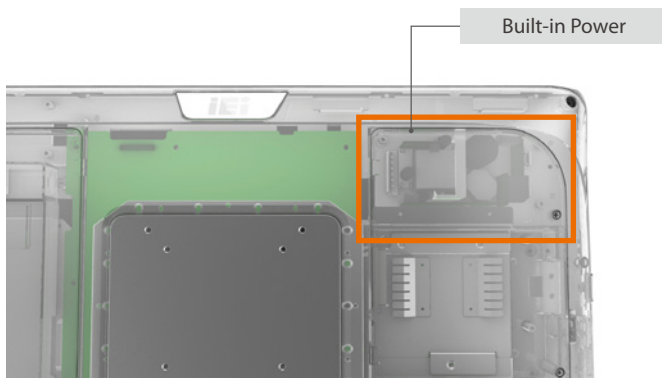

● Optional Built-in Battery

Uninterruptible Power System (UPS) is widely used in medical industry for securing patient's safety. The lateral expansion slot is available for a built-in battery which provides emergency power for 60 mins when the input source or main power fails under unexpected events.

* This feature needs to be requested before product shipment only and it will interfere with the lateral PCIe x4 expansion slot.

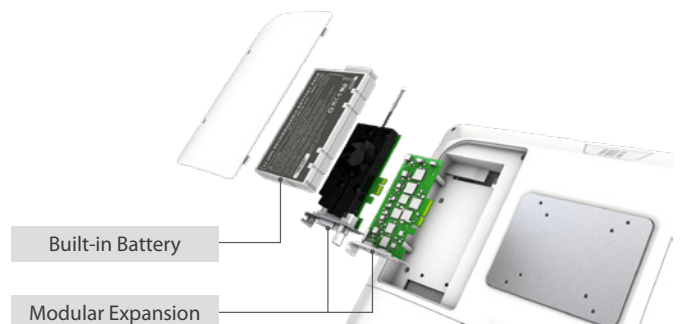

Specifications

Model		POCi-W22C-RPL	POCi-W24C-RPL
Display	Display Size	21.5" (16:9)	23.8" (16:9)
	Resolution	1920 x 1080	1920 x 1080
	Brightness (cd/m ²)	350	350
	Contrast Ratio	1000:1	1000:1
	LCD Color	16.7M (RGB 8-bit)	16.7M (RGB 8-bit)
	Pixel Pitch	0.24795 (H) x 0.24795 (V) mm	0.2745 (H) x 0.2745 (V) mm
	Viewing Angle (H/V)	178° / 178°	178° / 178°
	Backlight MTBF (hrs)	50,000 (LED backlight)	30,000 (LED backlight)
Touch	Touchscreen	Projected capacitive type with 10-point multi-touch	Projected capacitive type with 10-point multi-touch
	Touch Controller	EETI	EETI
	Surface Hardness	6H	6H
	Coating	Chemical etching AG	Chemical etching AG
Processor	Processor	13th Gen Intel® Core™ i5-1340PE/ i7-1370PE (Raptor Lake-P)	13th Gen Intel® Core™ i5-1340PE/ i7-1370PE (Raptor Lake-P)
LAN	LAN Controller	2 x Intel® I226 Ethernet Controller	2 x Intel® I226 Ethernet Controller
	Storage	2 x M.2 2280 M key (PCIe) with RAID	2 x M.2 2280 M key (PCIe) with RAID
	RAM	2 x 262-pin 4800MT/s dual-channel DDR5 SO-DIMM slots (system max. 64GB)	2 x 262-pin 4800MT/s dual-channel DDR5 SO-DIMM slots (system max. 64GB)
Expansion	Expansion	1 x PCIe x2 1 x M.2 2230 A-E key (PCIe+USB) 2 x M.2 2280 M key (PCIe) with RAID	1 x PCIe x2 1 x M.2 2230 A-E key (PCIe+USB) 2 x M.2 2280 M key (PCIe) with RAID
Audio	Speaker	2 x 2W speaker	2 x 2W speaker
	Microphone	1 x Digital microphone	1 x Digital microphone
Wireless	Wi-Fi	IEEE 802.11ax 2T2R module (Wi-Fi 6E) (M.2 2230 A-E key)	IEEE 802.11ax 2T2R module (Wi-Fi 6E) (M.2 2230 A-E key)
	Bluetooth	Bluetooth V5.2	Bluetooth V5.2
I/O	I/O	Bottom 1 x AC jack 1 x HDMI output 1 x USB Type-C (DP + USB 5V/3A) 1 x Combo audio-out/mic-in 2 x RS-232 2 x 2.5GbE LAN port 4 x USB 3.2 Gen 2 (10Gb/s) port Side 2 x USB 2.0 port	Bottom 1 x AC jack 1 x HDMI output 1 x USB Type-C (DP + USB 5V/3A) 1 x Combo audio-out/mic-in 2 x RS-232 2 x 2.5GbE LAN port 4 x USB 3.2 Gen 2 (10Gb/s) port Side 2 x USB 2.0 port
		Button	Button
On-Screen Display (OSD)	On-Screen Display (OSD)	1 x Power on/off 1 x Reading light on/off 1 x Brightness up 1 x Brightness down 1 x LCD & touch lock on/off 1 x DICOM mode app on/off (optional)	1 x Power on/off 1 x Reading light on/off 1 x Brightness up 1 x Brightness down 1 x LCD & touch lock on/off 1 x DICOM mode app on/off (optional)
Physical	Thermal	Fanless	Fanless
	Construction Material	Front bezel: Aluminum Rear cover: ABS+PC plastic	Front bezel: Aluminum Rear cover: ABS+PC plastic
	Mounting	Wall, Stand and Arm; VESA 75/100 compliant	Wall, Stand and Arm; VESA 75/100 compliant
	Weight (Net) (kg)	6.9 kg	8.1 kg
	Dimensions (LxWxH) (mm)	507.5 x 335.5 x 64.5 mm	567 x 370.6 x 63.9 mm
Power	Input	85V – 264V AC input	85V – 264V AC input
	Power Adapter	150W medical power adapter (optional) *	150W medical power adapter (optional) *
	Built-in Power Supply	150W, 85V – 264V AC, medical power supply	150W, 85V – 264V AC, medical power supply
Environment	Operating Temperature	0°C – 40°C	0°C – 40°C
	Storage Temperature	-20°C – 60°C	-20°C – 60°C
	Humidity	10% – 95% (non-condensing)	10% – 95% (non-condensing)
	Vibration	1G	1G
	Operating shock	5G peak acceleration (11ms duration)	5G peak acceleration (11ms duration)
	Non-operating shock	10G peak acceleration (11ms duration)	10G peak acceleration (11ms duration)
IP Level	Front: IP66	Front: IP66	
Operating System	Supported OS	Windows 11; Linux Ubuntu	Windows 11; Linux Ubuntu
Certification	EMC & Safety	CE, FCC Class B Part18 IEC 60601-1: 2005+AMD1:2012 (Edition 3.1) IEC 60601-1-2: 2014 (Edition 4.0)	CE, FCC Class B Part18 IEC 60601-1: 2005+AMD1:2012 (Edition 3.1) IEC 60601-1-2: 2014 (Edition 4.0)

Ordering Information

Part No.	Description
22"	POCi-W22C-RPL-i5/PC-R10 21.5" 350cd/m ² FHD medical panel PC with 13th generation 10nm Intel®Raptor Lake-P Core™ i5-1340PE 4.5GHz on-board processor,802.11a/b/g/n/ac/ax Wi-Fi 6E module,PCAP touchscreen w/ AG coating,R10
	POCi-W22C-RPL-i7/PC-R10 21.5" 350cd/m ² FHD medical panel PC with 13th generation 10nm Intel®Raptor Lake-P Core™ i7-1370PE 4.8GHz on-board processor,802.11a/b/g/n/ac/ax Wi-Fi 6E module,PCAP touchscreen w/ AG coating,R10
24"	POCi-W24C-RPL-i5/PC-R10 23.8" 350cd/m ² FHD medical panel PC with 13th generation 10nm Intel®Raptor Lake-P Core™ i5-1340PE 4.5GHz on-board processor,802.11a/b/g/n/ac/ax Wi-Fi 6E module,PCAP touchscreen w/ AG coating,R10
	POCi-W24C-RPL-i7/PC-R10 23.8" 350cd/m ² FHD medical panel PC with 13th generation 10nm Intel®Raptor Lake-P Core™ i7-1370PE 4.8GHz on-board processor,802.11a/b/g/n/ac/ax Wi-Fi 6E module,PCAP touchscreen w/ AG coating,R10

* To order the POCi series with a power adapter / DICOM module / a backup battery, please contact IEI's product manager for more information

Options

Item	Part No.	Description
RFID	19XS0Z787-0006301-000-RS	RFID reader for POCi-W24C-RPL, 13.56MHz and 125KHz dual band, IEI assembly only
	19XS0Z786-0006301-000-RS	RFID reader for POCi-W22C-RPL, 13.56MHz and 125KHz dual band, IEI assembly only
TPM	TPM-IN03-R10	20-pin Infineon SPI TPM 2.0 module, software management tool, firmware V7.63
OS Image	POCi-RPL-W11E64-H-R10	OS Image with Windows Embedded Standard 11 E High End 64-bit 2021 for POCi-RPL-i7 Series, RoHS
	POCi-RPL-W11E64-V-R10	OS Image with Windows Embedded Standard 11 E Value 64-bit 2021 for POCi-RPL-i5 Series, RoHS

IQ Mounting Options

Item	Part No.
Stand	STAND-A21-R10 (black)
	STAND-A21W-R10 (white)

Packing List

Item	Q'ty	Remark
Power Cord	1	European power cord, 183 cm, C13

POCi-W22C-RPL / POCi-W24C-RPL
I/O Interface

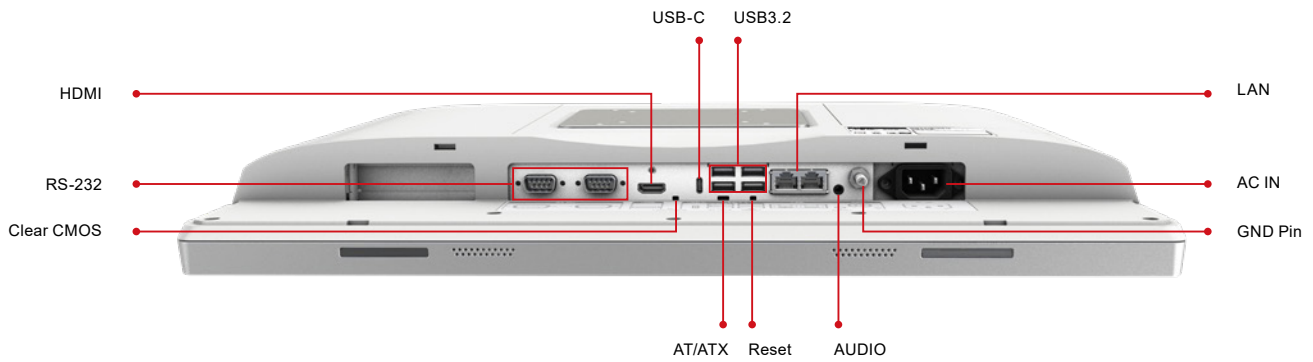

POCi-W22C-RPL
Dimensions (Unit: mm)

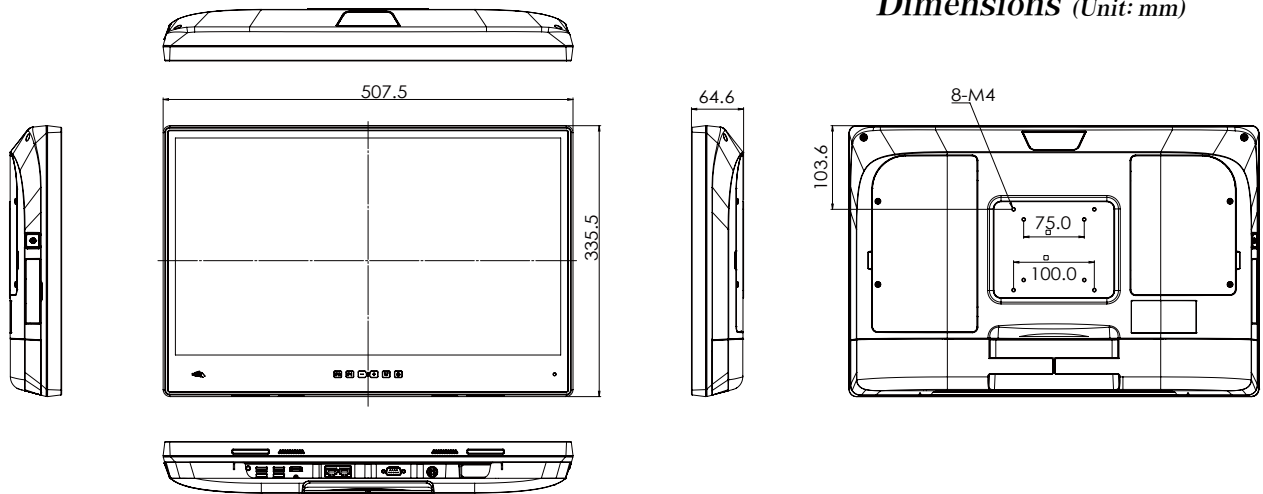

POCi-W24C-RPL
Dimensions (Unit: mm)

