

DN-843I-CT-1

3-channel 1 A Current Transformer



DN-843I-CT-10

3-channel 10 A Current Transformer



DN-843I-CT-20

3-channel 20 A Current Transformer



DN-843I-CT-50

3-channel 50 A Current Transformer

Features

- AC/DC Source Input
- Linear Attenuation Ratio
- High Current Input Measurement
- Isolation Input
- Channel to Channel Isolation
- Easily Wire Connection



Introduction

The maximum input range is from ± 1 A to ± 50 A and can be attenuated to from ± 1.6 V to ± 10 V. The "I" version provide 3000 Vdc intra-modules isolation and 3000 Vdc channel to channel isolation to avoid the noise interference from inputs to outputs or channel to channel. It can be used with the analog input modules such as I-7017 and I-7520 etc. to measure the high current.

Applications

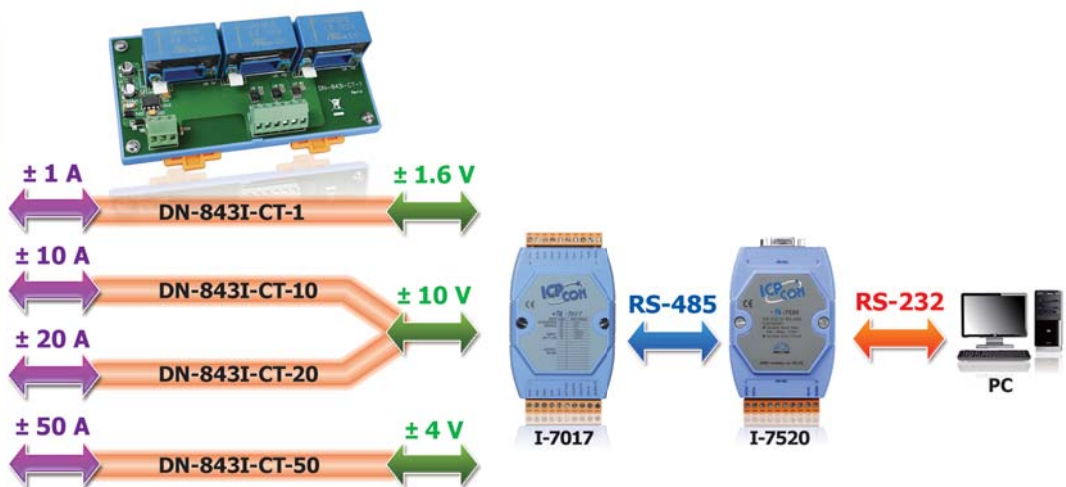

Installation

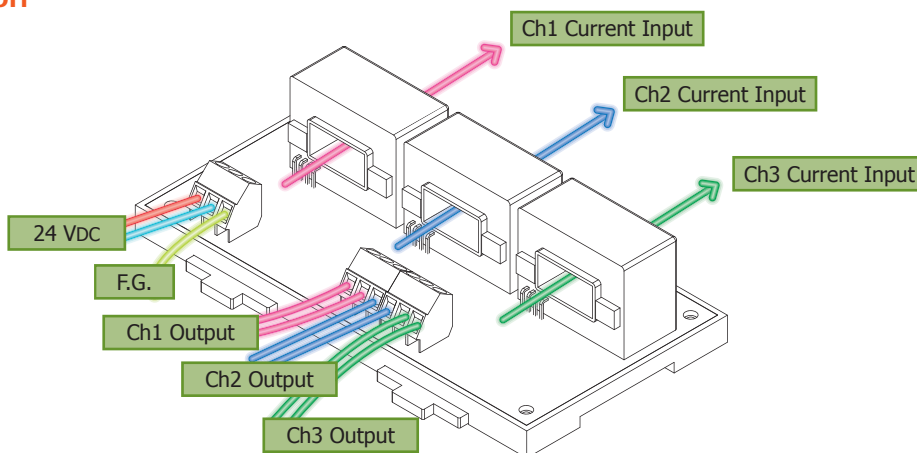

Specifications

Models	DN-8431-CT-1	DN-8431-CT-10	DN-8431-CT-20	DN-8431-CT-50
EMS Protection				
ESD (IEC 61000-4-2)	±4 kV contact for power line, input and output channels, ±8 kV air for random point			
CT				
Type	Solid Core (closed)			
Inside Diameter	20.4 X 10.4 mm			
Analog Input				
Channels	3			
Type	AC/DC Current			
Range	±1 A	±10 A	±20 A	±50 A
Accuracy	Zero ≤ 100mV, 3% of FSR	1% of FSR		
Bandwidth	50 KHz			
Input Impedance	> 1 MΩ			
Chanel to Channel Isolation	Yes, 3000 Vrms			
Intra-module Isolation	3000 VDC			
Analog Output				
Channels	3			
Type	AC/DC Voltage			
Range	±1.6 Vpp	±10 Vpp	±4 Vpp	
Power				
Input Range	+10 VDC ~ +24 VDC			
Consumption	1.2 W			
Mechanical				
Casing	Plastic			
Dimensions (mm)	148 x 83 x 39 (W x L x D)			
Installation	DIN-Rail Mounting			
Environment				
Operating Temperature	-25 ~ +75 °C			
Storage Temperature	-30 ~ +75 °C			
Humidity	10 ~ 90% RH, Non-condensing			

Dimensions (Units: mm)

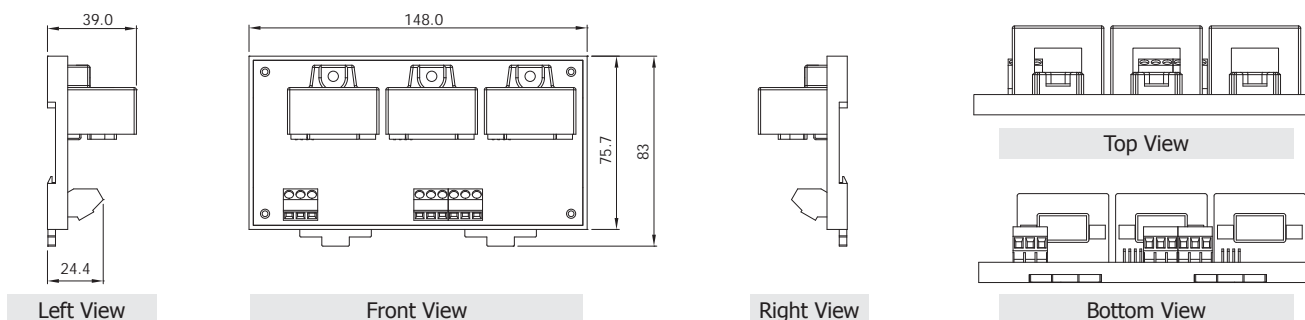

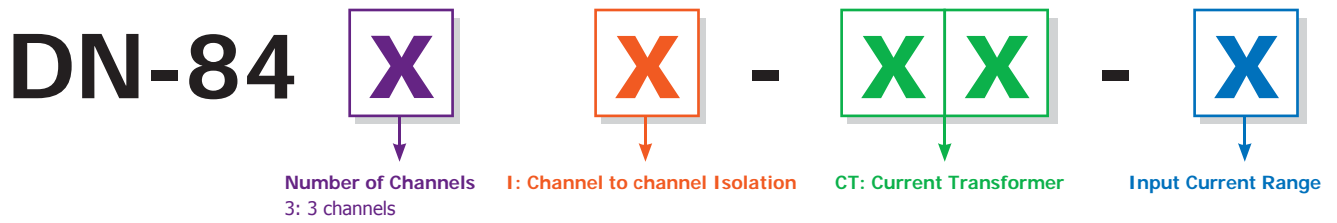

Selection Guide



Ordering Information

DN-843I-CT-1 CR	3-channel 1 A Current Transformer (RoHS)
DN-843I-CT-10 CR	3-channel 10 A Current Transformer (RoHS)
DN-843I-CT-20 CR	3-channel 20 A Current Transformer (RoHS)
DN-843I-CT-50 CR	3-channel 50 A Current Transformer (RoHS)

Accessories

 MDR-20-24 CR	24 V/1 A, 24 W Power Supply with DIN-Rail Mounting (RoHS)
 I-7017-G CR	8-channel Analog Input Module with DCON Protocol (Gray Cover) (RoHS)
 I-87017-G CR	8-channel Analog Input Module (RoHS)